

Piab MX suction cup



- For logistics, warehousing, e-commerce and recycling applications.
- Outstanding for picking different objects.
- A multi-purpose suction cup with extreme gripping capabilities on any surface.
- Very good for handling difficult bags, pouches, cardboard boxes and recycled objects.
- The cup is made of Duraflex®, a material that features the elasticity of rubber and wear resistance of polyurethane.
- The material has a fantastic elastic memory and “mark free” capabilities.
- Trippel durometer cup design: Thin soft lip, sturdy bellow and firm neck – gives outstanding sealing capabilities and great holding force in dynamic grips.
- A wide range of fitting options (uses piGRIP® fittings).
- Exceptional sealing capabilities at lower vacuum levels - forgiving for handling different types of objects, less vacuum flow needed.
- Energy saving - less need of high vacuum flows give significant reduction of compressed air usage.

Lifting force

Description	Vertical			Parallel		
	20 -kPa	40 -kPa	60 -kPa	20 -kPa	40 -kPa	60 -kPa
Lifting forces	19.8 N	24.9 N	33.0 N	13.9 N	17.4 N	23.1 N

Technical data

Description	Unit	Value
Internal volume	cm ³	16.0
Weight	g	10
Min. curve radius -60 kPa	mm	25.0
Max. vertical movement	mm	11.4
Application	-	Bag handling, Bag opening/thin paper - slip sheets/film
Material	-	Polyurethane, PUR
Colour	-	Yellow / Transparent blue
Suction cup model	-	MX
Suction cup shape	-	Multibellows
Hardness °Shore A	-	30 and 60 °Shore A
Temperature range (°C)	°C	10-50
Actuated outer diameter, max	mm	50

Material resistance, Polyurethane, PUR

Description	Value
Alcohol	Fair
Concentrated acids	Fair
Ethanol	Fair
Hydrolysis	Fair
Methanol	Poor
Oil	Excellent
Oxidation	Poor
Petrol	Fair
Wear resistance	Excellent
Weather & ozone	Excellent

Dimensional drawing

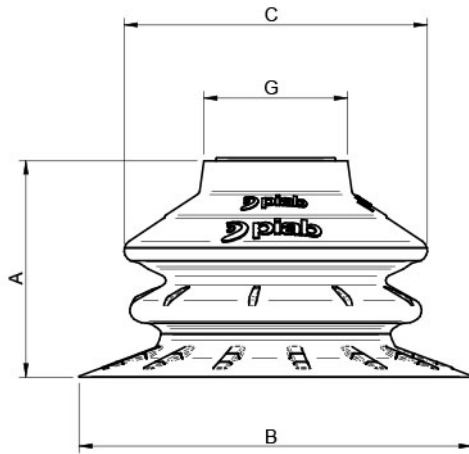

Product code	Description	Unit	Value
A	Building height	mm [inch]	29.2 [1.15"]
B	Diameter (lip)	mm [inch]	52.0 [2.05"]
C	Diameter (bellows)	mm [inch]	40.1 [1.58"]
G	Diameter (upper)	mm [inch]	19.0 [0.75"]

Ordering information – Current configuration

Description MX suction cup	Product code S.MX50P3060.XXX.00
Suction cup size	Ø 50mm
Suction cup material	Polyurethane, PUR
Hardness	30 and 60 °Shore A
Fitting type	None
Fitting size	None
Fitting style	None
Options	None

Ordering information, spare parts

Description	Art. No.
Suction Cup MX50P	0230370



Internal volume

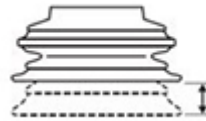

Max. vertical movement

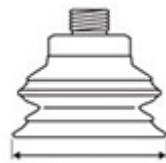

Diameter (lip)



Min. curve radius -60 kPa

Values specified in this data sheet are tested at (unless otherwise stated):

- Room temperature (20°C [68°F] ± 3°C [5.5°F]).
- Standard atmosphere (101.3 [29.9 inHg] ± 1.0 kPa [0.3 inHg]).
- Relative humidity 20-70%.
- Compressed air quality, DIN ISO 8573-1 class 4.

Storage guidelines (scan QR code)



Mounting instruction MX-cups (scan QR code)

