

Suction cup VL75FC, G1/4"-G1/8", 0202750



- Suitable for flat or slightly corrugated or curved surfaces
- Good stability and little inherent movement
- Recommended when the lifting force is parallel to the surface of the object
- Cleats prevent thin, sensitive objects from being deformed and gives extra friction when the lifting force is parallel
- Volume discounts available for big packs from 30-99 pieces with an even larger discount for big packs of 100 pieces and above
-
- PVC-free recycable material

General

Material	TPE-U
Suction cup model	FC
Suction cup shape	Flat Concave

Fitting

Fitting size	1/8", 1/4"
Fitting style	Female/Male
Fitting type	G-thread
Fitting option	None

Dimension

Height	38.3 mm (B)
Height 2	18 mm (D)
Inner diameter	12 mm (C)
Outer diameter	75 mm (A)

Performance — lifting forces

50 -kPa	113 N

Material

	TPE-U
Colour	Purple
Hardness	65 °Shore A
Temperature	0 – 60 °C

Dimensional drawings

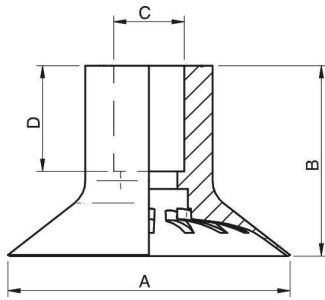

Values specified in the data sheet are tested at:

Room temperature	(20°C [68°F] ± 3°C [5.5°F])
Standard atmosphere	(101.3 [29.9 inHg] ± 1.0 kPa [0.3 inHg])
Relative humidity	0-100%
Compressed air quality	DIN ISO 8573-1 class 4

Spare parts

	Item no.
Suction cup VL75FC	0202103
Fitting VL D=Ø12, G1/4" - G1/8"	0202159

Accessories

	Item no.
Fitting VL D=Ø12, G3/8" - G1/4"	0202165
Fitting VL D=Ø12, 1/4"NPT - 1/8"NPSF	0202163
Fitting VL D=Ø12, 3/8" NPT - 1/4" NPSF	0202167