

# Suction cup VL60BL, 0202122



- Suitable for level adjustment
- Lifting movement to separate small and thin objects
- Less suitable when the lifting force is parallel to the surface of the object
- Volume discounts available for big packs from 30-99 pieces with an even larger discount for big packs of 100 pieces and above
- PVC-free recycable material

## General

Material	TPE-U
Suction cup model	BL
Suction cup shape	Multibellows

## Fitting

Fitting size	None
Fitting style	None
Fitting type	None
Fitting option	None

## Dimension

Height	76.3 mm (B)
Height 2	18 mm (D)
Inner diameter	12 mm (C)
Outer diameter	60 mm (A)

## Performance — lifting forces

	
50 -kPa	48 N

## Material

	TPE-U
Colour	Purple
Hardness	65 °Shore A
Temperature	0 – 60 °C

## Dimensional drawings

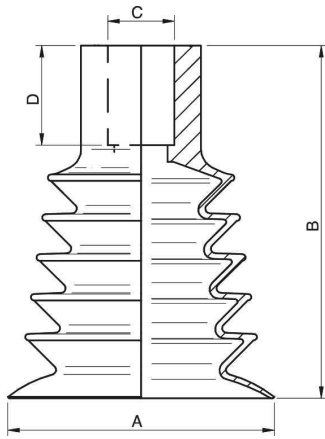

## Values specified in the data sheet are tested at:

Room temperature	(20°C [68°F] ± 3°C [5.5°F])
Standard atmosphere	(101.3 [29.9 inHg] ± 1.0 kPa [0.3 inHg])
Relative humidity	0-100%
Compressed air quality	DIN ISO 8573-1 class 4

## Accessories

	Item no.
Fitting VL D=Ø12, G1/4" - G1/8"	0202159
Fitting VL D=Ø12, G3/8" - G1/4"	0202165
Fitting VL D=Ø12, 1/4"NPT - 1/8"NPSF	0202163
Fitting VL D=Ø12, 3/8" NPT - 1/4" NPSF	0202167