

Suction cup VL20BX, 0202109



- Suitable for level adjustment.
- Several short bellows in one lifting device can handle objects with height differences and varying shapes, for example embossed or corrugated plates
- The lifting movement can be used to separate small and thin objects
- Only light weight objects should be handled when the lifting force is parallel to the surface of the object in order to achieve good precision and safe lifting movement
- Volume discounts available for big packs from 30-99 pieces with an even larger discount for big packs of 100 pieces and above
- PVC-free recycable material

General

Material	TPE-U
Suction cup model	BX-P
Suction cup shape	Bellows

Fitting

Fitting size	None
Fitting style	None
Fitting type	None
Fitting option	None

Dimension

Height	19.5 mm (B)
Height 2	9 mm (D)
Inner diameter	6 mm (C)
Outer diameter	20 mm (A)

Performance — lifting forces

50 -kPa	7 N

Material

	TPE-U
Colour	Purple
Hardness	65 °Shore A
Temperature	0 – 60 °C

Dimensional drawings

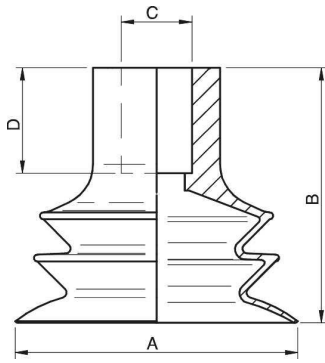

Values specified in the data sheet are tested at:

Room temperature	(20°C [68°F] ± 3°C [5.5°F])
Standard atmosphere	(101.3 [29.9 inHg] ± 1.0 kPa [0.3 inHg])
Relative humidity	0-100%
Compressed air quality	DIN ISO 8573-1 class 4

Accessories

	Item no.
Fitting VL D=Ø6, G1/8" - M5	0202156
Fitting VL D=Ø6, G1/4" - G1/8"	0202157
Fitting VL D=Ø6, 1/8" NPT - M5	0202160
Fitting VL D=Ø6, 1/4" NPT - 1/8" NPSF	0202161