



Item no: 0100552

Fitting 75, G3/8" female, with cone valve

A variety of fittings for suction cups.

- Suits suction cups: B75, B75P, B75-2, F75, F75P, FC100P
- With cone valve only for: F75

General

Material	SS, AL, NBR
Temperature	-20 - 90 °C
Weight, min.	75 g

Fitting

Fitting size	3/8"
Fitting style	Female
Fitting type	G-thread

Dimensional drawings

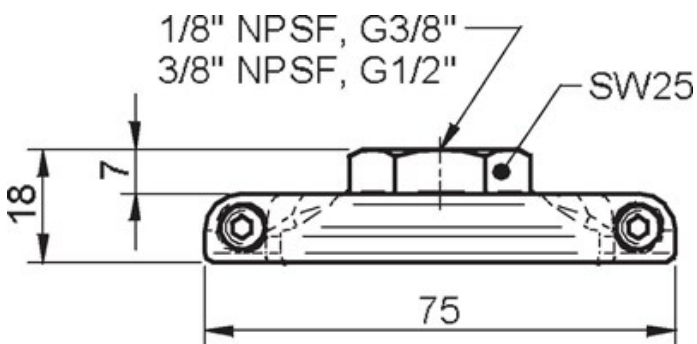

Spare parts

0100729 | Cone Valve for Fitting 75