

Item no: 0110249

Vacuum switch VS4016, G1/8" male, 50 -kPa

Our line includes inductive universal, electro-mechanical and pneumatic vacuum switches that are pre-set or adjustable.

- Pre-set vacuum switch with digital output.
- Very low weight and small format, push-in or thread connections.
- PNP NO/NC or NPN NO/NC output functions.

General

Material	TPU, PA, SS, CUZNAU
Temperature	-25 - 85 °C
Weight	5 g

Electrical data

Current, inductive, max.	0.1 A
Current, resistive, max.	0.4 A
Display	LED indicator
Safety classification	IP40
Voltage	24 (12-30) VDC
Voltage drop, max (100mA/24V inductive load)	0.055 VDC

Dimension

Height	21.5 mm
Length	16 mm
Width	16 mm

Performance

Feed pressure, max. (@ vacuum connection) 0.2 MPa

Signal function"

Hysteresis 5-7 kPa
Signal range 47 - 55 -kPa

Pneumatic data

Valve function NO, NC

Dimensional drawings 

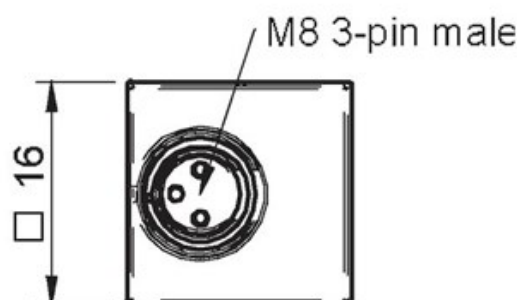
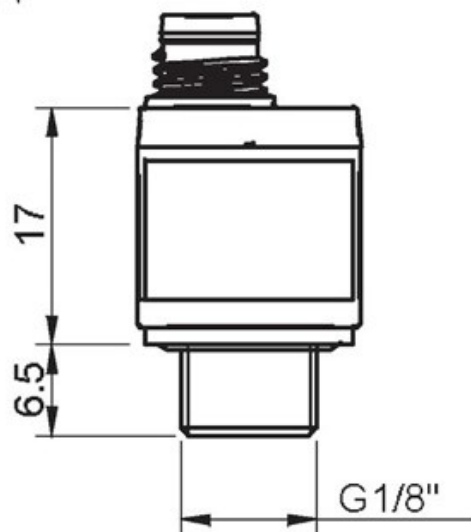

Accessories

0108141 | Cable M8 3-pin female L=2m