



Item no: 3116671

Vacuum filter G3/8" (10 µm)

To filter dust and other small particles from the vacuum flow. Reduces the risk of operation breakdown or stoppage in the pump.

- To filter dust and other small particles from the vacuum flow.
- Reduces the risk of operation breakdown or stoppage in the pump.
- Replaceable filter element.
- Available with special filter element with increased filter area

General

Material	PA, PE, PP
Filter area	30 cm ²
Removal efficiency	10 μm
Temperature	-20 - 80 °C
Weight	73 g

Pneumatic data

Flow (nominal)	2.5 NI/s
Pressure	-0.1 - 0 MPa
Volume, internal	45 cm ³

Dimensional drawings

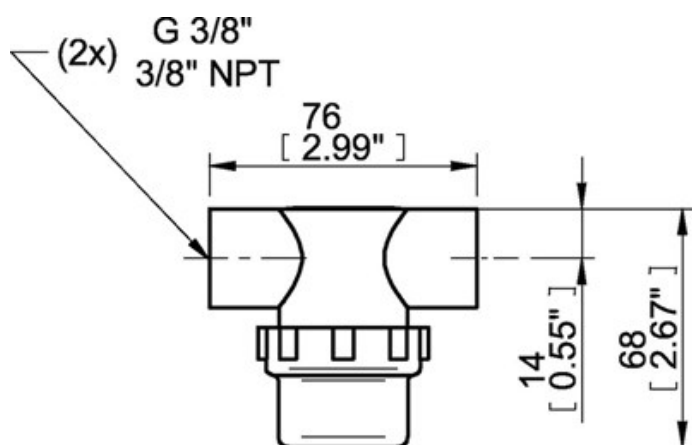

Spare parts

0202951 | Filter element 1/8" - 3/8" (120μm), 3pcs

0128421 | Filter element 1/8" & 1/4" & 3/8" (10 μm), 3 pcs